

GREENER'S
BUDGET LUMBER
BARREN - (715) 517-5137
BIRCHWOOD - (715) 514-7442

EAVE SIDE 2/GABLE SIDE 2 3D PERSPECTIVE

Construction
Maestro
Paul Patten & Sonnet
Estimating Software Version 3.0

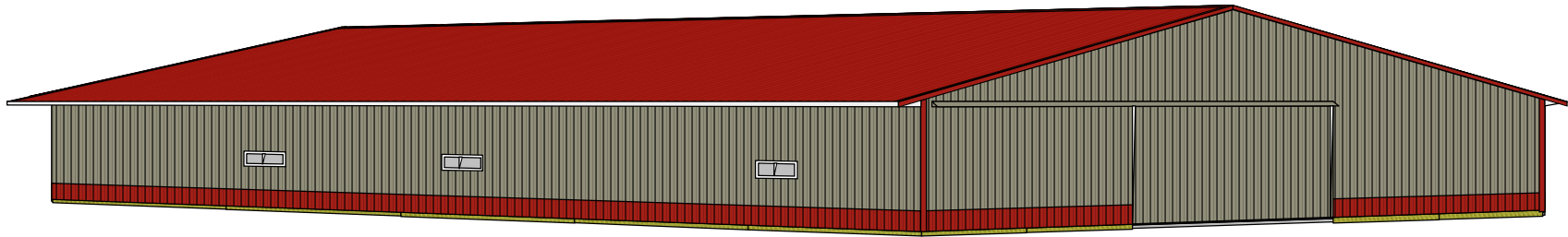

GREENER'S
BUDGET LUMBER
BARBEN - (715)571-5527
BOSTONWOOD - (715)564-7842

EAVE SIDE 1/GABLE SIDE 1 3D PERSPECTIVE

Construction
Maestro
Plan Room & Storage
Estimating Software Version 3.0

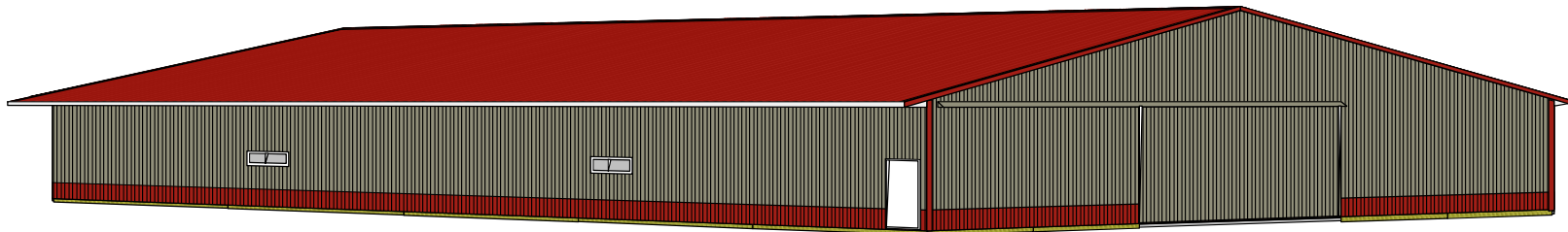

Overhang Detail

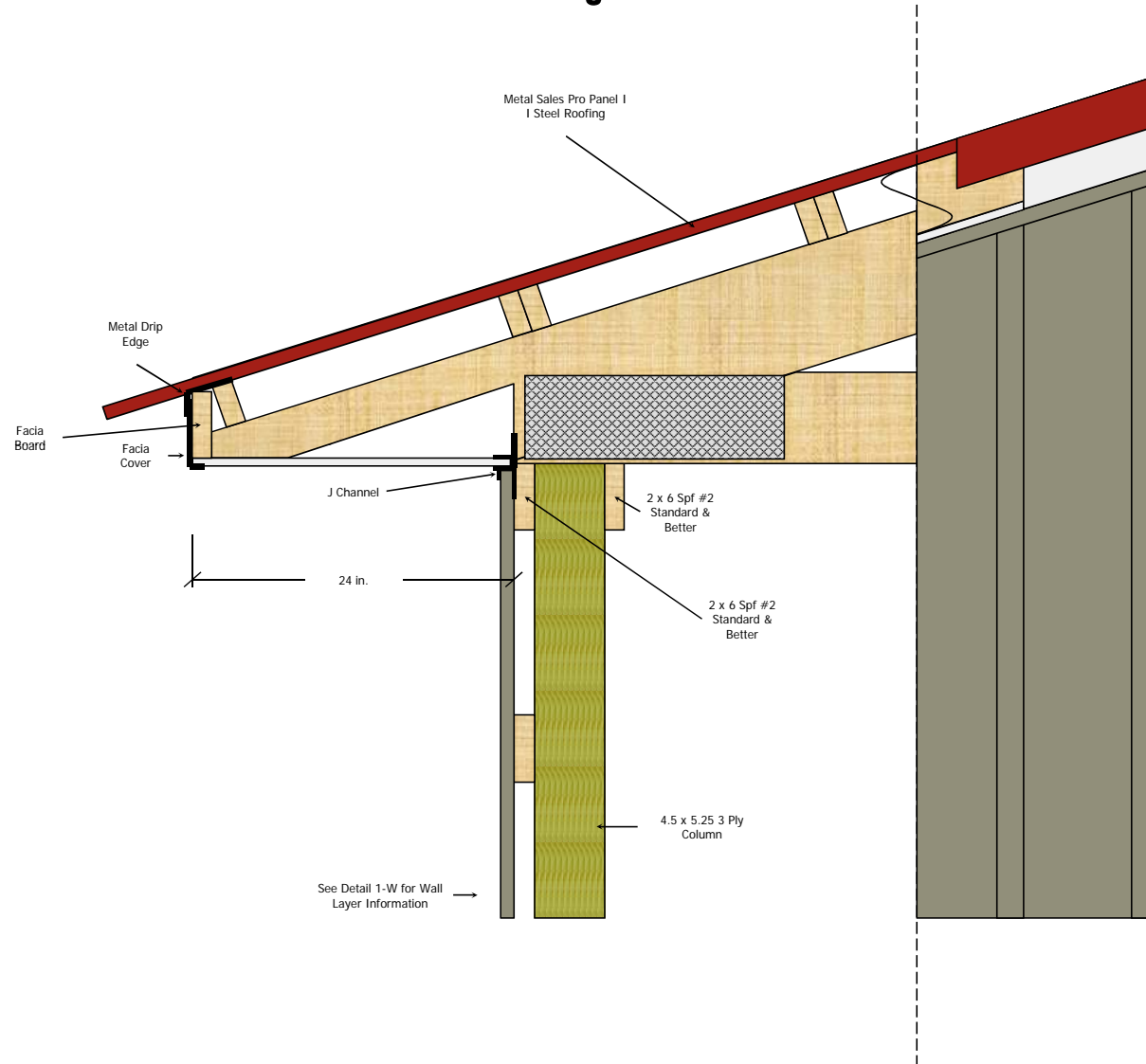

GREENER'S
BUDGET LUMBER
BARRON - (715)537-5537
BIRCHWOOD - (715)354-7842

Wall Section 1-W

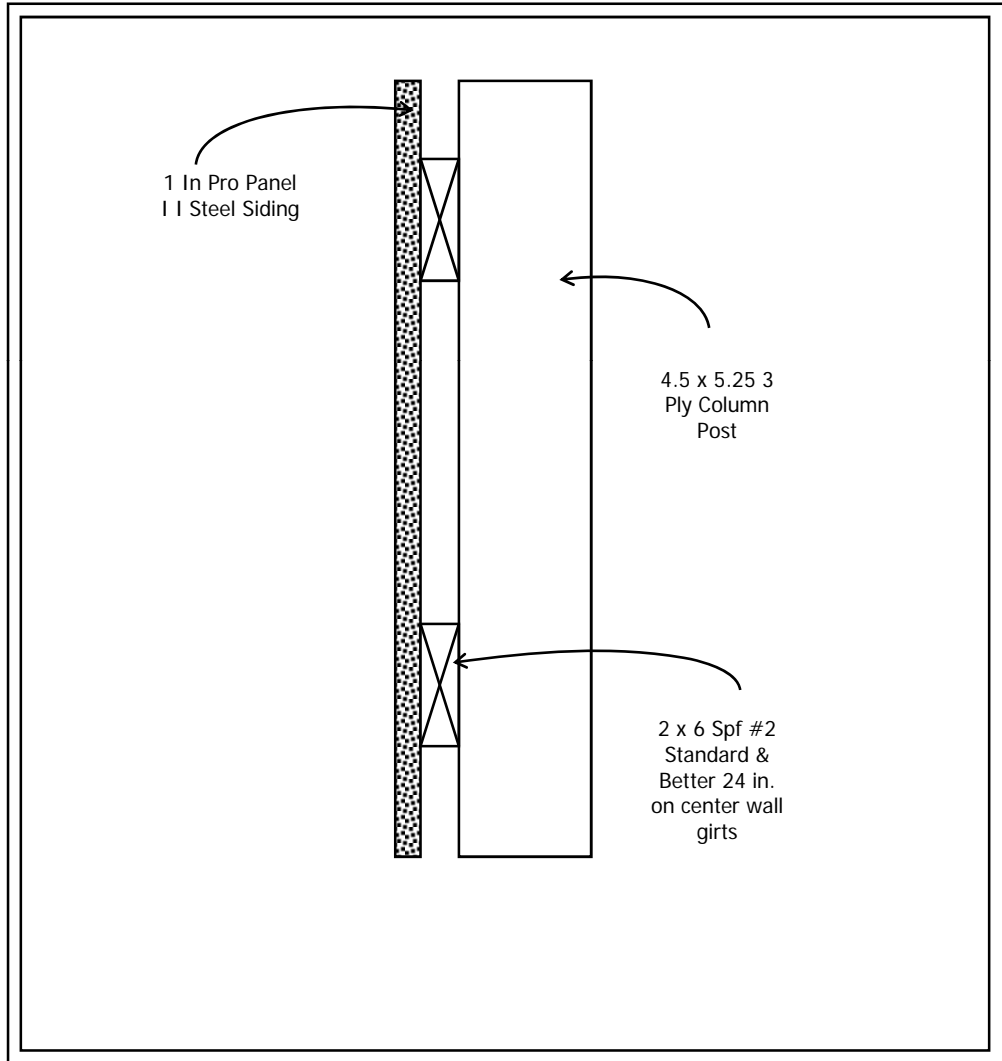

Cross Section Detail

Truss Information

30-4-0-1 Truss Loading
 96 in. O.C. Spacing, Standard Heel
 Trusses are Setting on Truss
 Carriers

2 x 4 Truss Seat Bracing Ran Through the
 Bottom Chord 8' On Center

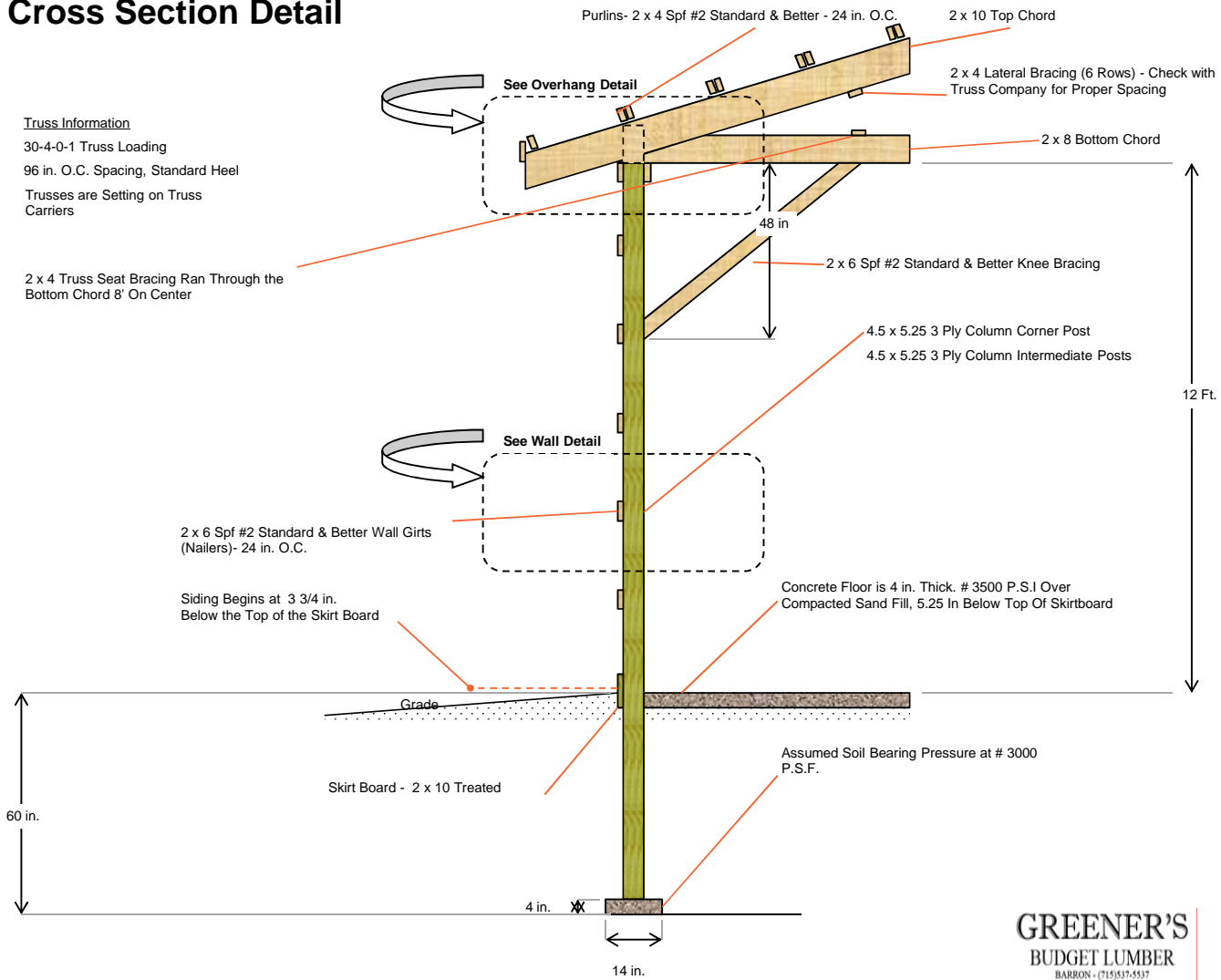

GREENER'S
 BUDGET LUMBER
 BARRON - (715)537-5537
 BIRCHWOOD - (715)554-7842

Eave 1

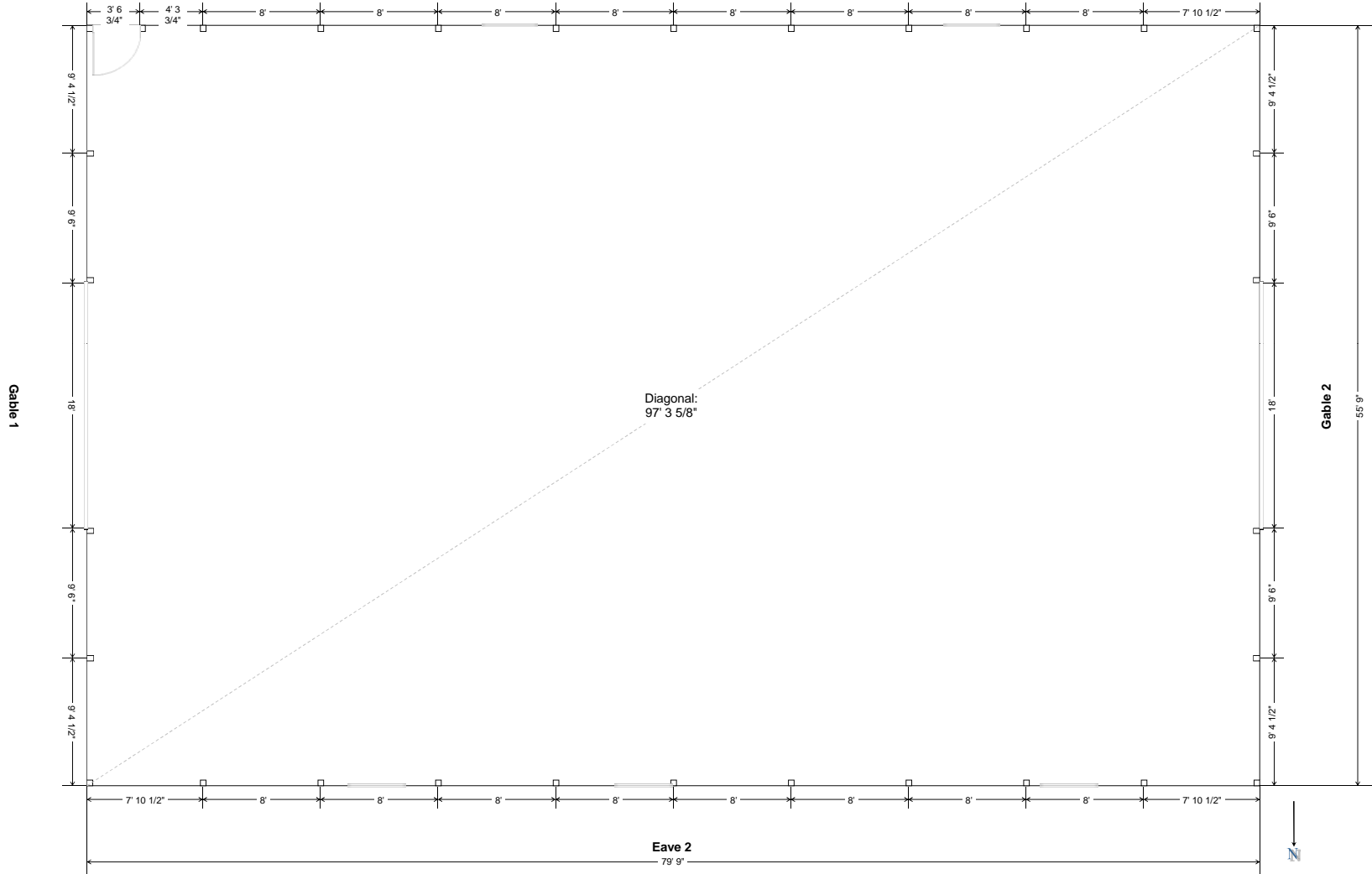

NORTH SIDE-EAVE SIDE 2 WALL GIRT VIEW

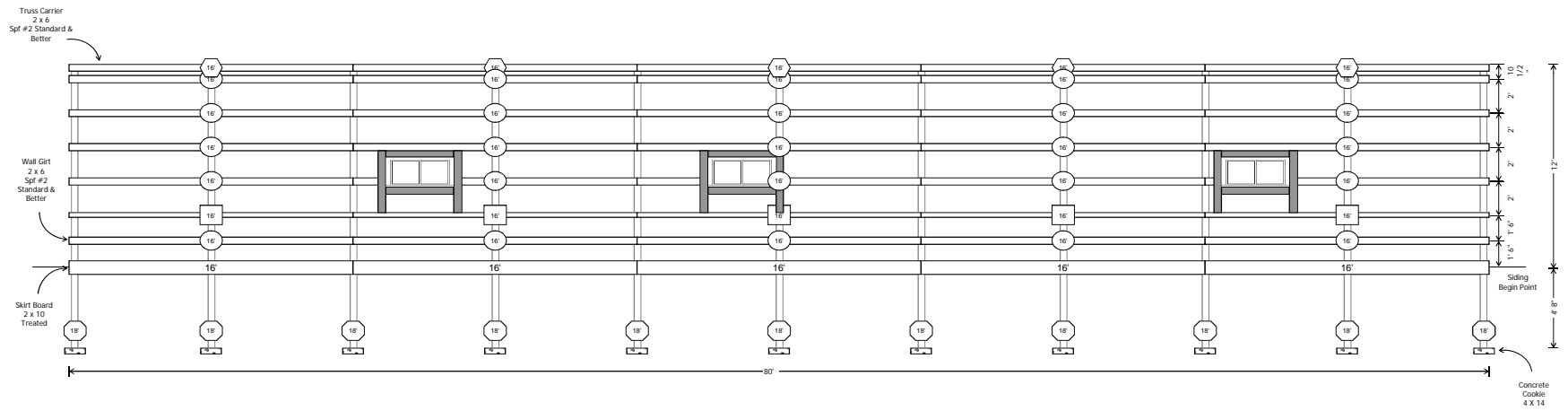

SOUTH SIDE-EAVE SIDE 1 WALL GIRT VIEW

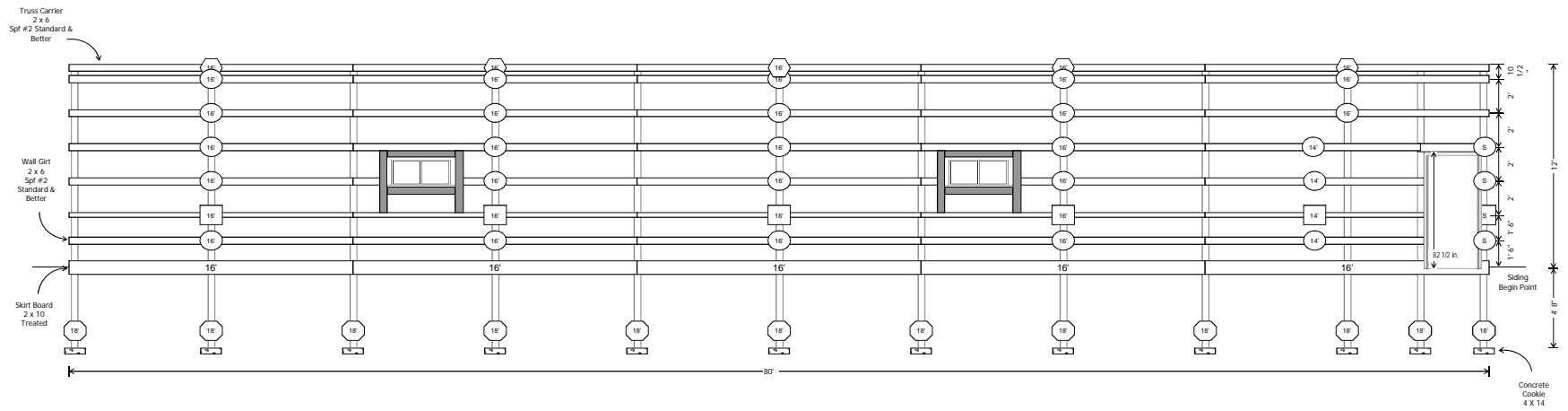

WEST SIDE-GABLE SIDE 2 WALL GIRT VIEW

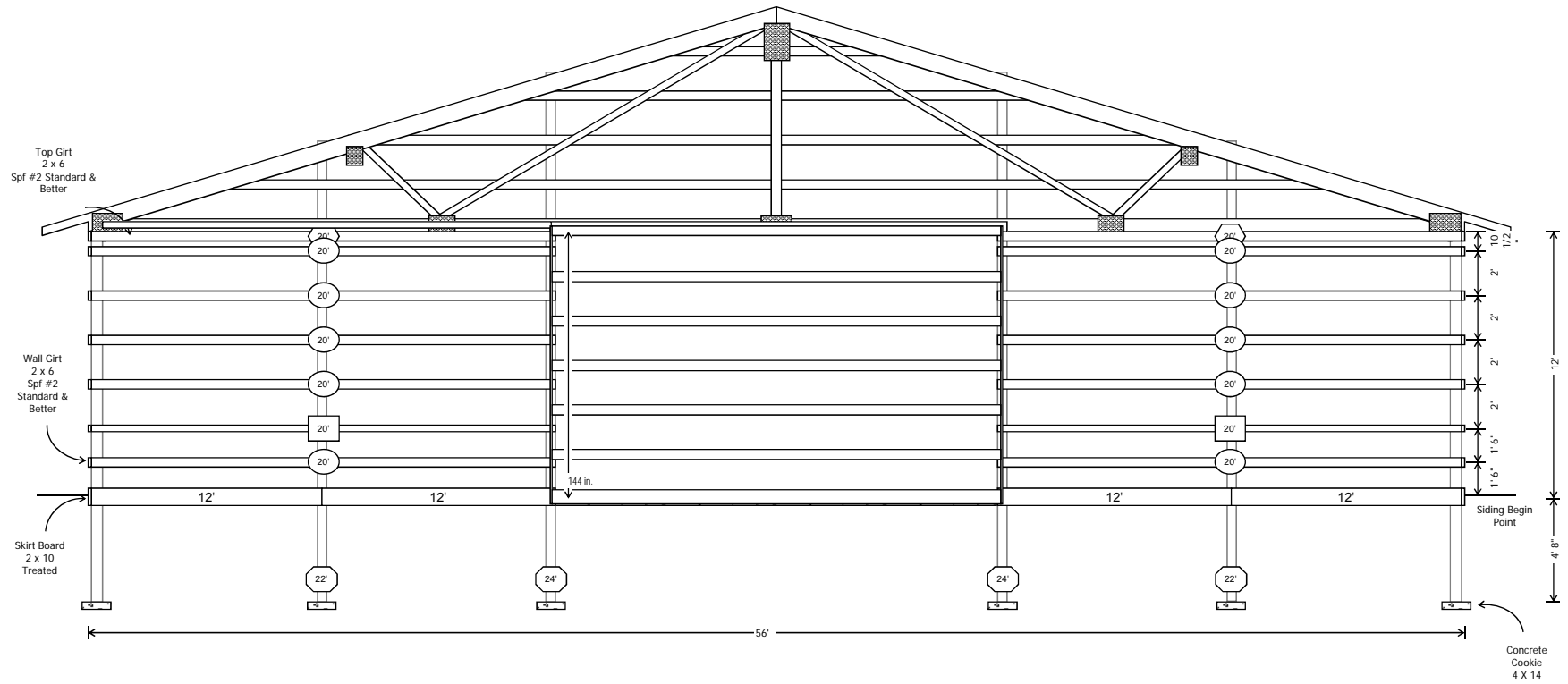

EAST SIDE-GABLE SIDE 1 WALL GIRT VIEW

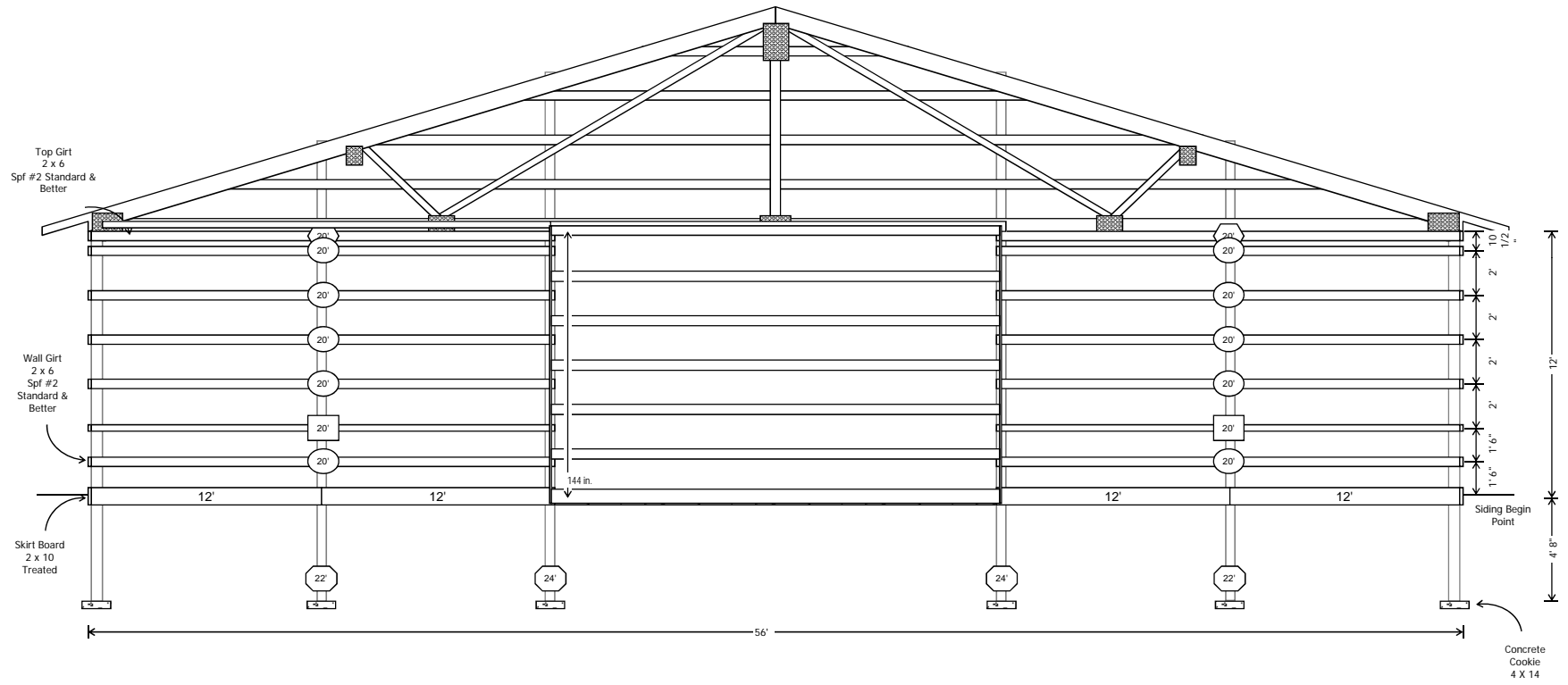

NORTH SIDE-EAVE SIDE 2 TRUSS AND PURLIN LAYOUT

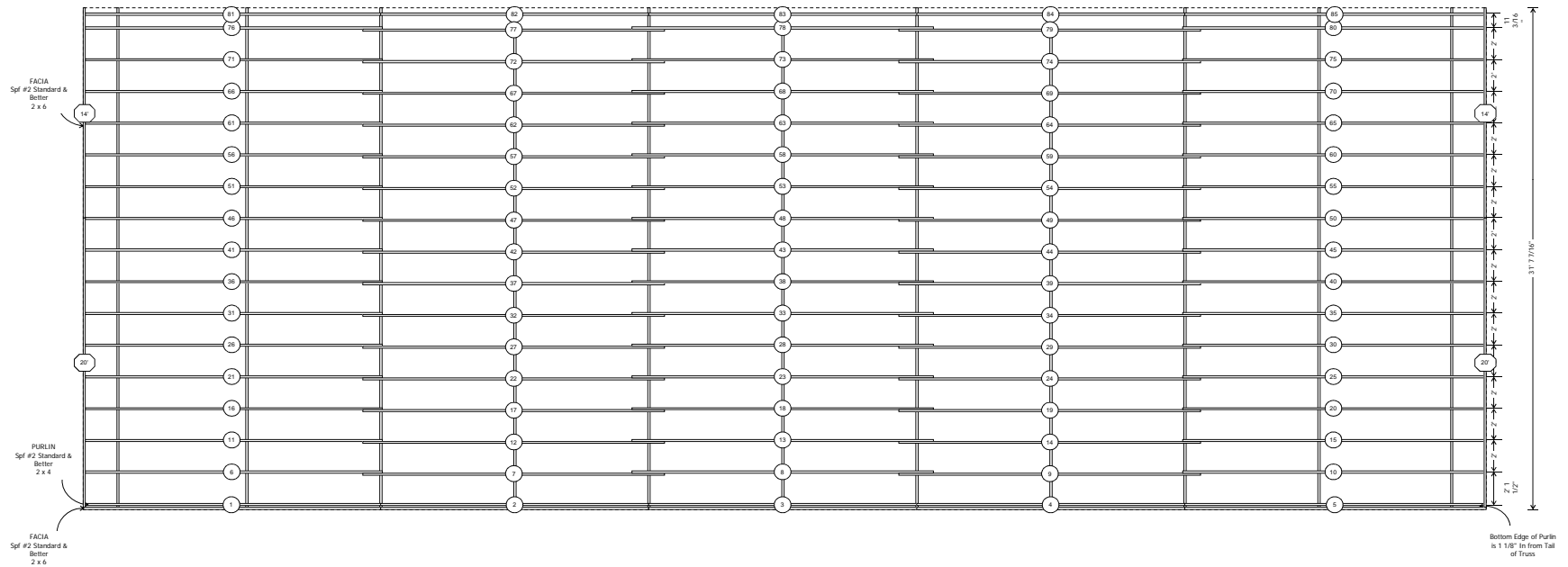

SOUTH SIDE-EAVE SIDE 1 TRUSS AND PURLIN LAYOUT

